

## Venus planter ø 62x60

by Marcel Wanders

The Venus Collection is a stunning creation by visionary designer Marcel Wanders, exclusively for Vondom. With meticulous attention to detail, these contemporary planters feature captivating curves that effortlessly add character and personality to any setting, whether it's a sleek patio, stylish balcony or vibrant garden.

Crafted in Europe, these designer planters are not only functional, they are works of art that enhance the beauty of your outdoor space. Perfect for anyone who appreciates contemporary design, the Venus collection transforms any environment into a sophisticated oasis while accommodating a variety of plant sizes. Enhance your outdoor spaces with these exquisite planters that seamlessly blend elegance and innovation.



## Info

---

### Description

Weight: 9.02 Kg

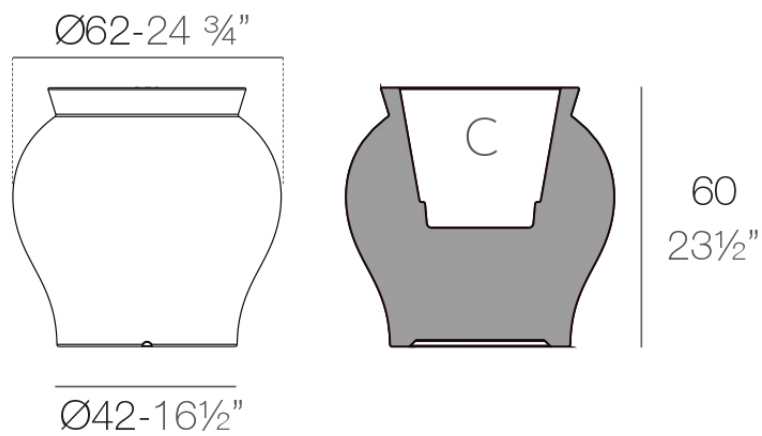

VENUS Macetero 60 cm

C = 25 L

VENUS Planter 23  $\frac{1}{2}"$

C = 6  $\frac{1}{2}$  gal

## Finishes

---

### finishes

---

#### BASIC

Ref. 67022A



white 2001



ecru 2003



tortora 2004



cream 2017



camel 2020



clay 2022



garnet 2015



brown 2008



green 2016



blue 2018



gray 2005



anthracite 2006



black 2002



ecru granite



cream granite



ice 2101

#### Matt Polyethylene

#### SELF-WATERING

Ref. 67022R

# VONDOM



white 2001



ecru 2003



tortora 2004



cream 2017

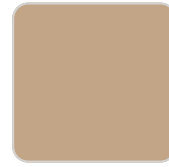

camel 2020

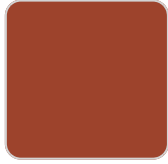

clay 2022

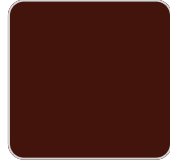

garnet 2015



brown 2008

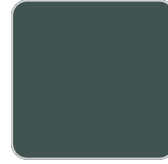

green 2016



blue 2018



gray 2005



anthracite 2006



black 2002

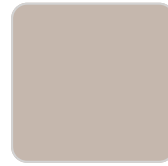

ecru granite



cream granite



ice 2101

Self-watering system included in all planters except those with basic finish

## LACQUERED Ref. 67022RF



white 3101



ecru 3103



tortora 3104



cream 3117



garnet 3113



brown 3125



green 3116



blue 3118



gray 3105



anthracite 3106



black 3102

Lacquered Polyethylene

## lighting

---

WHITE LED  
Ref. 67022W



ice 2101

White internally lit unit with LED technology. Available only in matte ice white finish.

RGBW LED DMX  
Ref. 67022D

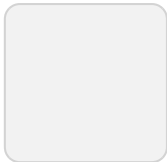

ice 2101

Unit with internal lighting with RGBW LED technology and remote control unit for switching colors. Also controlled by DMX-1024 (wireless), enabling communication between one or more products simultaneously via the DMX transmitter (not included). There are two options to choose from: Professional XLR DMX and Home WIFI DMX. (Remote control included).

Optional battery

RGBW LED BATTERY

Ref. 67022Y



ice 2101

Unit with internal lighting with battery-powered RGBW LED technology. Includes charger and remote control for switching colors and charger. Available only in matte ice white finish.

## RGBW LED DMX BATTERY

Ref. 67022DY



ice 2101

Unit with internal lighting with RGBW LED technology and remote control unit for switching colors. Also controlled by DMX-1024 (wireless), enabling communication between one or more products simultaneously via the DMX transmitter (not included). There are two options to choose from: Professional XLR DMX and Home WIFI DMX. (Remote control included).

## Ambients

---

