

Venus planter ø 83x80

by Marcel Wanders

The Venus Collection is a stunning creation by the visionary Marcel Wanders exclusively for Vondom. Designed with meticulous attention to detail, this planter features captivating curves that effortlessly add character and personality to any setting.



Info

Description

Weight: 16.02 Kg

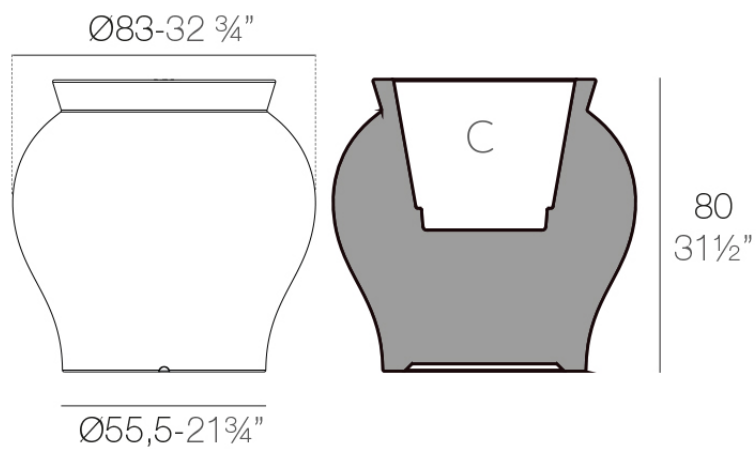

VENUS Macetero 80 cm
VENUS Planter 31 $\frac{1}{2}"$

C = 58 L
C = 15 $\frac{1}{4}$ gal

Finishes

finishes

BASIC

Ref. 67021A



ice



notte blue



crema

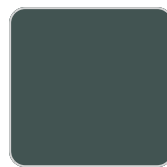

green

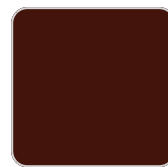

purjai red



orange



white



black



bronze



steel



anthracite



red



khaki



taupe



ecru



beige

Matt Polyethylene

SELF-WATERING

Ref. 67021R

VONDOM



ice



notte blue



crema

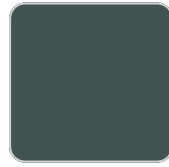

green

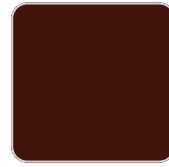

purjai red



orange



white



black



bronze



steel



anthracite



red



khaki



taupe



ecru



beige

Self-watering system included in all planters except those with basic finish

LACQUERED

Ref. 67021RF



notte blue



crema



purjai red



orange

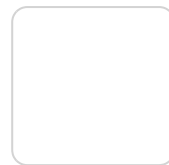

white



black



bronze



steel



anthracite



red

VONDOM



khaki



taupe



ecru



beige



modo green



champany

Lacquered Polyethylene

lighting

WHITE LED

Ref. 67021W



ice

White internally lit unit with LED technology. Available only in matte ice white finish.

RGBW LED DMX

Ref. 67021D

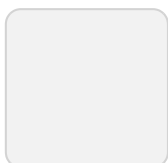

ice

Unit with internal lighting with RGBW LED technology and remote control unit for switching colors. Also controlled by DMX-1024 (wireless), enabling

VONDOM

communication between one or more products simultaneously via the DMX transmitter (not included). There are two options to choose from: Professional XLR DMX and Home WIFI DMX. (Remote control included).

Optional battery

RGBW LED BATTERY

Ref. 67021Y



ice

Unit with internal lighting with battery-powered RGBW LED technology. Includes charger and remote control for switching colors and charger. Available only in matte ice white finish.

RGBW LED DMX BATTERY

Ref. 67021DY

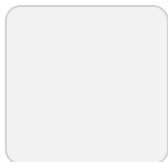

ice

Unit with internal lighting with RGBW LED technology and remote control unit for switching colors. Also controlled by DMX-1024 (wireless), enabling communication between one or more products simultaneously via the DMX transmitter (not included). There are two options to choose from: Professional XLR DMX and Home WIFI DMX. (Remote control included).

Ambients

