

## Tulum coffee table

by Eugeni Quitllet

Designed by Eugeni Quitllet, Tulum is a versatile collection of designer furniture made to harmonize effortlessly with modern living and diverse garden styles worldwide. Each piece in this collection reflects Eugeni Quitllet's commitment to blending functionality with aesthetic appeal.

Inspired by the serene beauty of the outdoors, the Tulum collection embodies a timeless elegance that blends seamlessly into a variety of garden styles. Whether placed in a tranquil garden oasis or on a contemporary patio, Tulum furniture enhances outdoor spaces with its sophisticated design and ergonomic comfort.



## Info

---

### Description

The coffee table in the collection is characterised by its aluminium structure treated with epoxy paint and precise welding, guaranteeing durability and strength. Its surface is made of Indonesian teak wood

slats, adding a touch of natural elegance.

This table perfectly combines high quality materials with an aesthetic design.

Weight: 14 Kg

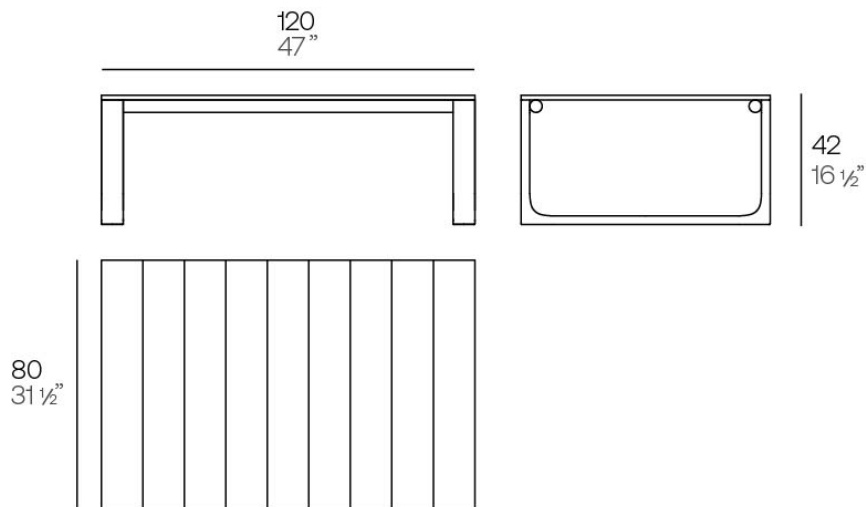

Tulum. Mesa Café  
Tulum. Coffee Table  
ref. 65074

## Finishes

---

### finishes

---

#### ALUMINIUM

Ref. 65074E



white



smoked



ecru



tortora

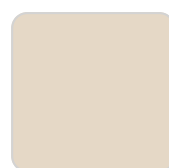

cream

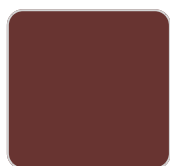

garnet



brown



green



blue



gray



anthracite



black

### tabletops

---

#### Teak

Ref. 65074TBL



natural teak



weathered teak

## Ambients

---

