

Vela table 200x100x72

by Ramón Esteve

Vela Collection, designed by Ramon Esteve for Vondom. The aim of this collection of modern outdoor furniture and planters is to provide the same level of comfort and quality as indoor furniture, while maintaining its distinctive features.



Info

Description

Made of polyethylene resin by rotational moulding. 100% Recyclable. Item suitable for indoor and outdoor use. Available in different finishes.

Weight: 82.85 Kg

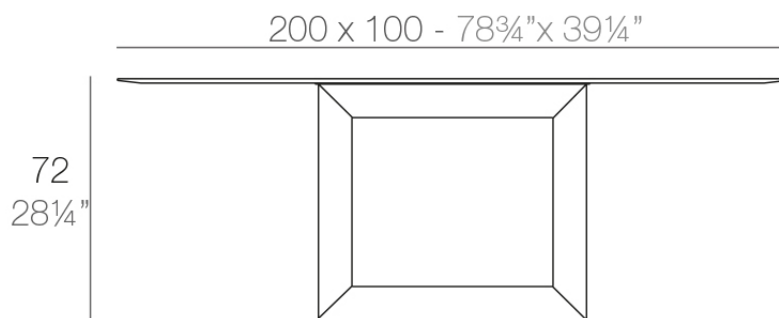

VELA Mesa
VELA Table

Finishes

finishes

BASIC

Ref. 54050FG



notte blue



crema



purjai red



orange

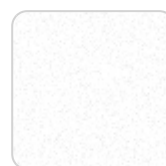

white



black



bronze



steel



anthracite



champany



red



khaki



taupe

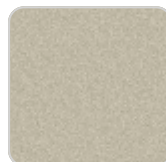

ecru



beige



ice



green

Matt Polyethylene

LACQUERED

Ref. 54050F

VONDOM



notte blue



crema



modo green



purjai red



orange



white



black



bronze



steel



anthracite



champany



red



khaki



taupe



ecru



beige

Lacquered Polyethylene

lighting

WHITE LED
Ref. 54050W



ice

White internally lit unit with LED technology. Available only in matte ice white finish.

VONDOM

RGBW LED
Ref. 54050L



ice

Unit with internal lighting with RGBW LED technology and remote control unit for switching colors. Available only in matte ice white finish. Remote control included.

RGBW LED DMX
Ref. 54050D



ice

Unit with internal lighting with RGBW LED technology and remote control unit for switching colors. Also controlled by DMX-1024 (wireless), enabling communication between one or more products simultaneously via the DMX transmitter (not included). There are two options to choose from: Professional XLR DMX and Home WIFI DMX. (Remote control included).

Optional battery

RGBW LED BATTERY
Ref. 54050Y



ice

Unit with internal lighting with battery-powered RGBW LED technology. Includes charger and remote control for switching colors and charger. Available only in

VONDOM

matte ice white finish.

RGBW LED DMX BATTERY

Ref. 54050DY



ice

Unit with internal lighting with RGBW LED technology and remote control unit for switching colors. Also controlled by DMX-1024 (wireless), enabling communication between one or more products simultaneously via the DMX transmitter (not included). There are two options to choose from: Professional XLR DMX and Home WIFI DMX. (Remote control included).

tabletops

HPL

Ref. VVAR02176

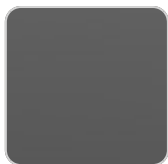

black(black edge)



ecru(black edge)

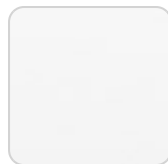

white(black edge)

HPL black edge

Ambients

