

## Vases table ø60x74

by JM Ferrero

VASES Collection, is made up of flowerpots, furniture and lighting designed by the Valencian designer JM Ferrero. The shapes of the pieces draw inspiration from diamond cutting, resulting in clear-cut shapes with great style that create a visually striking impact.



## Info

---

### Description

Made of polyethylene resin by rotational moulding. 100% Recyclable. Item suitable for indoor and outdoor use. Available in different finishes.

Weight: 5.92 Kg

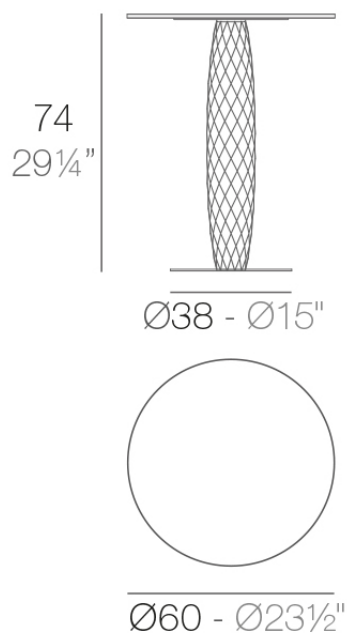

VASES Mesa Redonda Ø60  
VASES Round Dining Table Ø23 1/2"

## Finishes

---

### finishes

---

#### LACQUERED

Ref. 47073F



notte blue



crema



modo green



purjai red



orange



white



black



bronze



steel



anthracite



champany



red



khaki



taupe



ecru



beige

#### Lacquered Polyethylene

### tabletops

---

#### HPL

Ref. 47073

# VONDOM



orange



notte blue



ice



crema

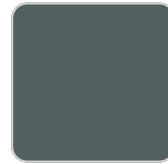

green



purjai red



white

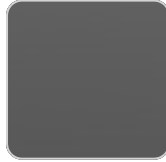

black

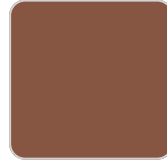

bronze



steel



anthracite



red

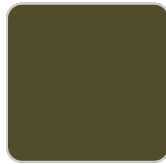

khaki



taupe



ecru

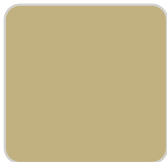

beige

HPL black edge

## tabletops

---

HPL

Ref. VVAR03006



black(black edge)

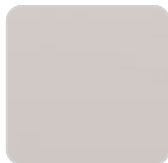

ecru(black edge)

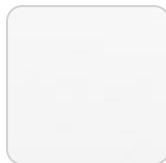

white(black edge)

HPL black edge

Solid Core

# VONDOM

Ref. VVAR03006



crema



castoro fiber

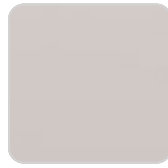

piombo gray

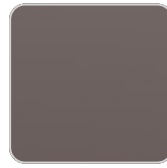

cacao



kandia black



modo green

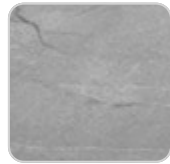

yule gray



gioia bianco



purjai red



yule brown



british gray



notte blue

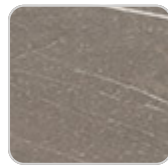

pulpis gray



traffic gray

# VONDOM