

Milos coffee table

by Jean-Marie Massaud

The Milos collection is the fruit of a collaboration between Vondom and renowned French designer Jean-Marie Massaud, combining simplicity and functionality in pieces that stand out for their bold design and comfort. With soft curves and shapes inspired by nature, the outdoor furniture collection offers a unique experience, which is why it has been awarded the prestigious Red Dot 2024 design award.



Info

Description

The coffee tables represent the essence of the Mediterranean lounge style of the Milos collection. These tables are manufactured, featuring a cement surface available in different finishes.

They stand out for their iroko wood legs, which not only add a touch of warmth and sophistication, but also ensure the stability and connection with nature that is characteristic of Milos.

Weight: 30.4 Kg

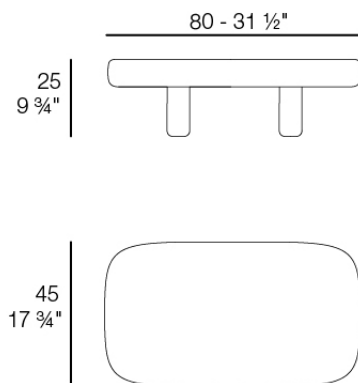

MILOS Mesa Centro 80 x 45
MILOS Low Table 31 1/2 x 17 3/4"
Ref. 70018

Finishes

finishes

CEMENT
Ref. 70018



tortora



cream

Ambients

