

## Hamptons low tables

by Ramón Esteve

Hamptons, the **new collection of designer outdoor furniture** consists of a set of pieces where a careful selection of fabrics and patterns evoke that “lifestyle” where elegance is perceived in the finest details.



## Info

---

### Description

The low table in the collection stands out for its aluminium structure, which makes it lightweight and sturdy, ideal for outdoor use. The surface is made of HPL sheets, a durable and easy to maintain material.

The polished aluminium legs add a touch of elegance and shine. Available in a wide variety of colours for both the aluminium frame and the HPL surface.

Weight: 27.87 Kg

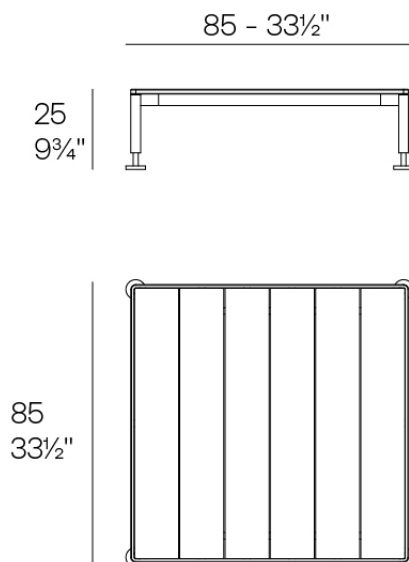

HAMPTONS Mesa Baja 85x85x25  
HAMPTONS Low Table 33 1/2"x33 1/2"x9 3/4"

## Finishes

---

### finishes

---

#### ALUMINIUM

Ref. 54812



white



smoked



ecru



tortora



cream



garnet



brown



green



blue

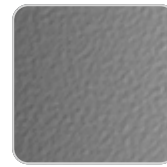

gray



anthracite



black

Lacquered aluminium profile.

### tabletops

---

#### Solid Core

Ref. 54810CEN

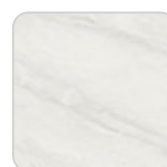

# VONDOM

ecru stone

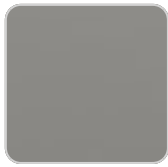

smoked

tortora stone



white (white edge)

black stone

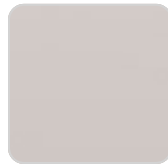

ecru

gray stone

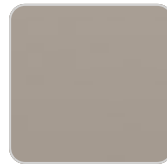

tortora

white stone



cream



garnet



brown



green



blue



anthracite

## HPL

Ref. 54810CEN



black(black edge)

## HPL black edge

## Solid Core wood

Ref. 54810CEN

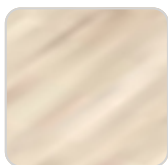

oak1



oak2

## Ambients

---

