

## Frame aluminium table 200x90x74

by Ramón Esteve

Frame, outdoor collection by Ramon Esteve, comes from generating serene and timeless shapes using the framework as elementary geometry. The endless possibilities offered by the material using advanced technology, was the motivation to explore the limits.



## Info

---

### Description

Extruded aluminum with cast lacquered aluminum base. HPL Table top ó Dekton Table top. Item suitable for indoor and outdoor use. HPL Table top.

Weight: 36.12 Kg

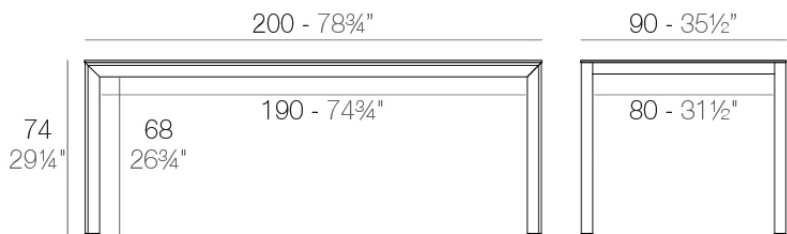

FRAME Mesa 200x90cm  
FRAME Dinning Table 78 3/4"x35 1/2"

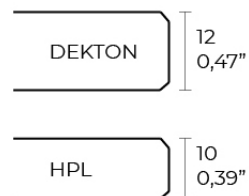

## Finishes

---

### finishes

---

ALUMINIUM  
Ref. 54239FM



white



british gray



traffic gray



black



ecru

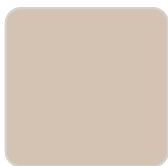

crema



castoro fiber

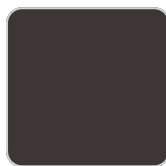

cacao



notte blue

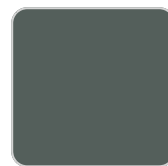

modo green

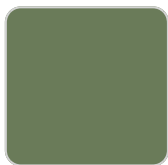

pickle

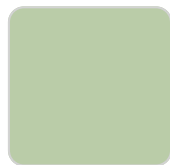

almond

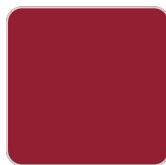

red

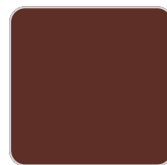

purjai red

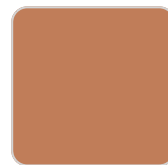

melon

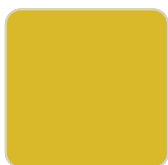

mostaza

Lacquered aluminium profile.

### tabletops

---

HPL  
Ref. VVAR02583

# VONDOM



black(black edge)

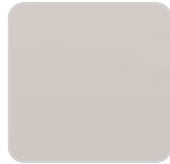

ecru(black edge)



white(black edge)

## HPL black edge

## Solid Core

Ref. VVAR02584

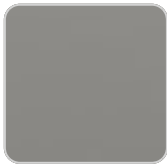

british gray



notte blue

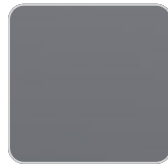

traffic gray



white (white edge)



crema



yule brown

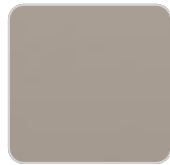

castoro fiber

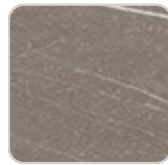

pulpis gray



piombo gray



kandia black



cacao



modo green

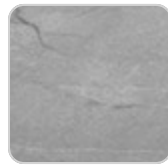

yule gray



gioia bianco



purjai red

## Dekton

Ref. VVAR02836



kelya



entzo

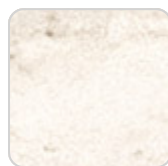

danae

## Ambients

---

