

Faz wood mesa alta ø60x105

por Ramón Esteve

La colección Faz de Vondom, diseñada por Ramón Esteve, es una de las más icónicas de la firma. Destaca por su diseño modular y sofisticación, representando la armonía, serenidad y atemporalidad a través de formas minerales y rotundas. Faz transforma los ambientes con su combinación única de materia y luz, creando una atmósfera envolvente y exclusiva.



Info

Descripción

Mesa con sobre de HPL o DEKTON y una base compuesta de una estructura metálica y patas de madera. La estructura metálica está pintada con pintura epoxi a juego con el tablero.

La madera está disponible en dos acabados. Evitar la exposición directa al sol y la lluvia.

Peso: 10.17 Kg

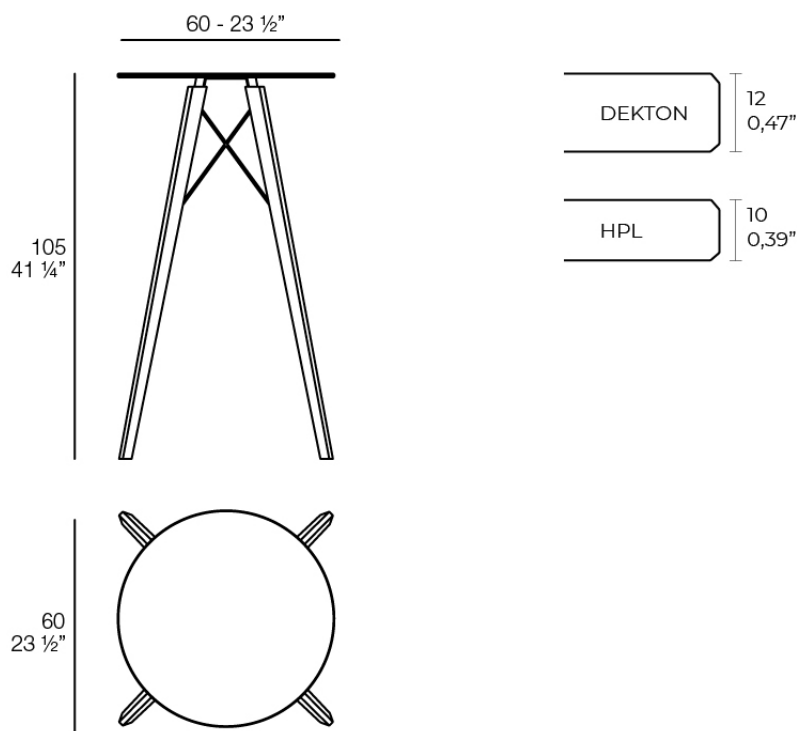

FAZ WOOD Mesa Alta Ø60
FAZ WOOD Dinning table Ø23 1/2"

Acabados

tableros

HPL

Ref. 54318



white(black edge)

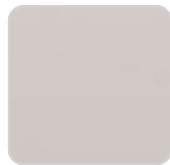

ecru(black edge)

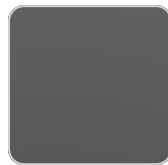

black(black edge)

HPL black edge

Solid Core

Ref. 54318B

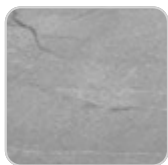

gray stone



white stone



smoked



ecru stone

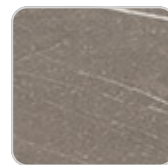

tortora stone

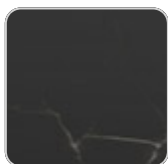

black stone

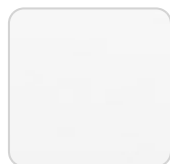

white (white edge)

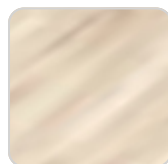

oak1

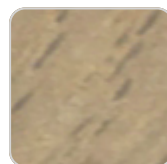

oak2

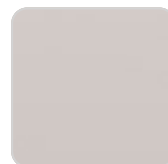

ecru

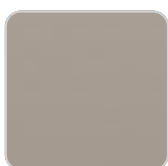

tortora

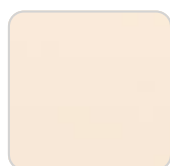

cream



garnet



brown



green

VONDON



blue



anthracite

HPL solid core

estructura

ALUMINIO

Ref. VVAR03098



white

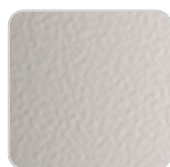

ecru



black

Perfil de aluminio en acabado lacado.

patas

Fresno

Ref. VVAR03082



wood 1



wood 2

Ambients

